



Quick Guide



售后客服

MTQ Throttle Panel



01 Parameters

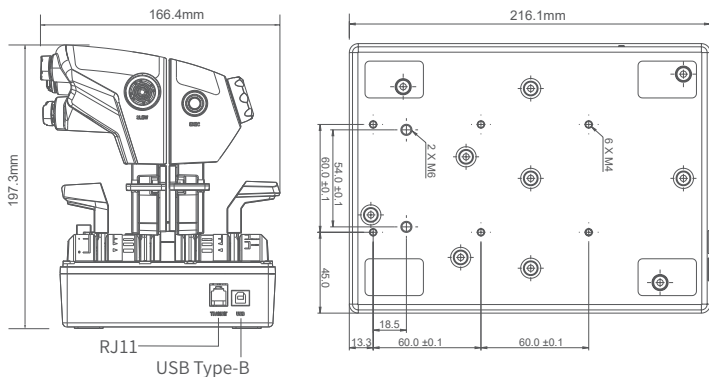

02 User Guide

Connecting to PC

1. Direct Connection to PC

Use the included USB cable to connect the Type-B end to the corresponding port on the back of the MOZA MTQ Throttle Quadrant, and the Type-A end to your PC. If connected successfully, the device's light will gradually illuminate, and the MOZA Cockpit will indicate that the device is connected.

* If the device fails to light up, check whether the light brightness is turned off in the MOZA Cockpit.

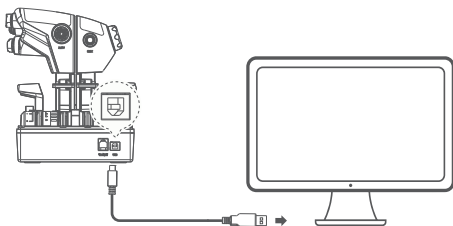

2. Connecting to PC through MOZA Flight Base

Connect one end of the included RJ11 cable to the corresponding port on the MOZA MTQ Throttle Quadrant and the other end to the MOZA Flight Base. Power on the base; if connected successfully, the device light will illuminate, and the MOZA Cockpit will indicate that the device is connected.

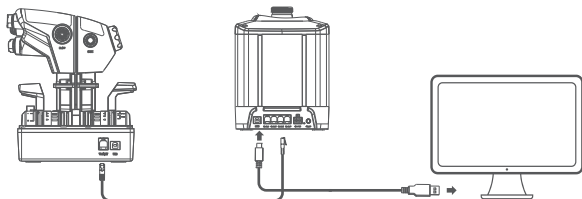

Adjusting Sliding Friction

To adjust the sliding friction of the levers, use the included wrench to turn the screw clockwise to increase or counterclockwise to decrease.

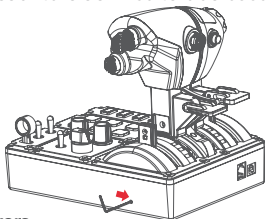

Replacing the Throttle Levers

To replace the throttle levers, follow these steps:

1. Loosen the Fixing Screw

Use the provided wrench to loosen the fixing screw at the indicated position.

2. Remove the Existing Levers

Once the screw is loosened, gently pull out the existing throttle levers.

3. Install the New Lever Module

Align the new throttle lever module with the connecting rod, then insert it fully until it is secure without wobbling.

4. Secure the New Levers

Using the provided wrench and screwdriver, tighten the screw at the indicated position to ensure the new lever module is firmly secured in place.

*Note: TQA and TQB need to be purchased separately.

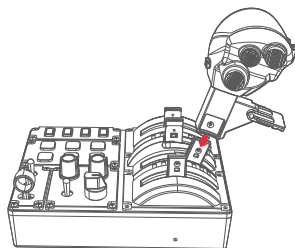
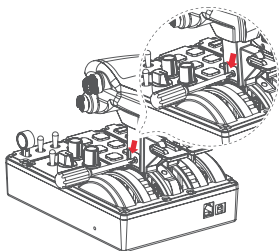

Installation of the MTQ Support Plate

Align the mounting holes of the MTQ Support Plate with the threaded holes at the bottom of the MTQ equipment. Using the provided wrench, insert the two screws and tighten them clockwise until secure.

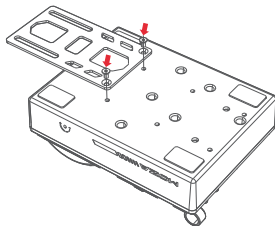

03 Software Introduction

Panel Settings

When the throttle levers are replaced, the right-side diagram automatically updates to match the new layout and inputs.

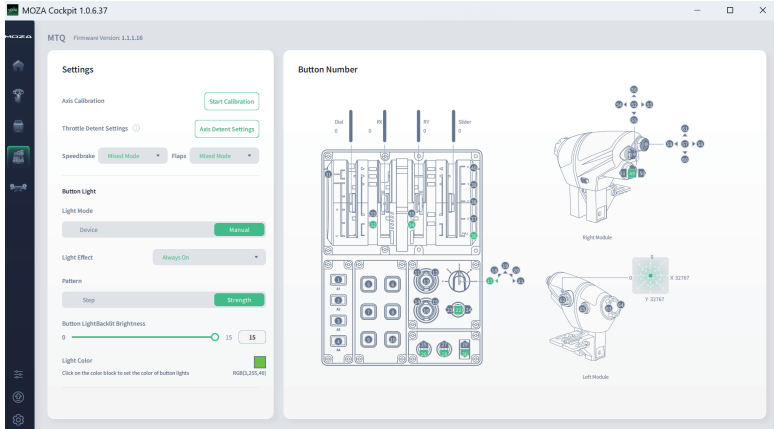

Axis Calibration

The throttle quadrant sticks are factory-calibrated and ready for immediate use. If you notice a mismatch between the physical movement of the sticks on the TQF and the corresponding axis output, you may need to perform axis calibration.

To begin calibration:

- Click the "Start Calibration" button.
- Follow the on-screen instructions. Before the countdown ends, move all sticks (throttle, flap, and speedbrake) back and forth through their full range of motion.
- Once calibration is complete, the sticks will function properly.

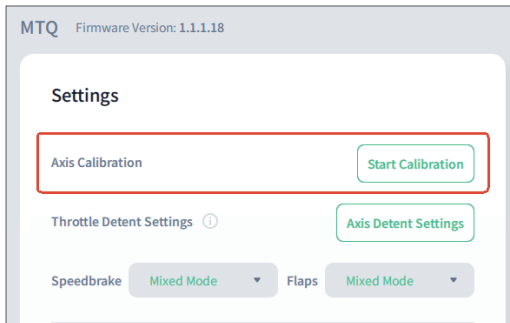

Axis Detent Function

This feature maps throttle travel to game input with precision and defines Cutoff, Idle, and Afterburner zones.

Users can calibrate detent positions via the settings window; six virtual buttons will be added for mapping each zone. The Axis Output panel shows logical axis values (top) and physical travel percentage (bottom) for easy alignment and feedback.

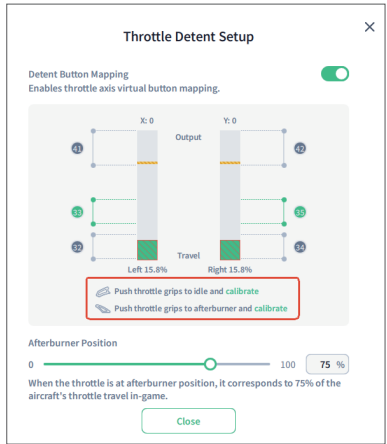

Speedbrake and Flap Axis Mapping Modes

The speedbrake and flap levers support three modes:

- Button Mode: Outputs only button signals, no axis data.
- Axis Mode: Outputs raw analog axis values.

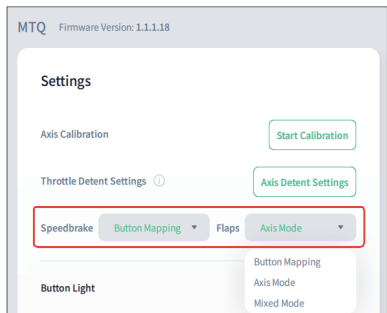

Button Light

Lighting Control Modes

Lighting control modes determine how the software manages the button lighting. Users can choose between two modes:

- Device Mode: Button lighting responds dynamically to input from a selected control axis (e.g., the speedbrake axis). As the axis value changes (e.g., the speedbrake axis value increases), the lights react according to the selected lighting pattern.
- Manual Mode: Manually adjust the button lighting using the brightness slider and lighting effect dropdown in the software interface.

Button Lighting & Effects

This device supports customizable backlighting and lighting effects. Users can configure lighting modes and colors via the Cockpit software to create a personalized visual experience.

Supported features:

- Multiple lighting modes (Static, Blinking, Breathing)
- Button lighting feedback
- 16.7 million-color RGB customization
- Pattern and brightness adjustment

Click the color swatch in the MOZA Cockpit interface to select your preferred lighting style and brightness.

04 Precautions

- Do not expose the device to liquids or humidity as it may cause fire or electric shock.
- Avoid using the device in direct sunlight.
- Do not use MOZA flight sim gear with the MOZA racing gear.
- Recommended indoor temperature: 5°C ~ 35°C.
- For your safety and well-being, please monitor your gaming time and take breaks as needed.
- The device is not suitable for children under the age of 6, small accessories may pose a choking hazard!
- Children under 13 should have adult supervision.
- It is strictly forbidden to disassemble the equipment by yourself, failure to adhere to this will result in loss of warranty.
- The equipment must be connected with the factory-supplied power supply to ensure the electrical safety and the protection of user rights and interests.
- In order to ensure user safety, parts repair or replacement can only be carried out by officially authorized repair centers.
- Non-standard power supplies are strictly prohibited even if data such as related voltages match.
- Use only AC power provided by a standard wall outlet to avoid damage to the product.
- Do not expose the device to heat sources.
- Unplug the power cord of the device if it will not be used for a long time.
- If you find any abnormality, please stop using it immediately and seek help from MOZA representatives or authorized repair centers.
- Stay tuned to our official website and social media platforms for the latest product updates.

01 基本数据

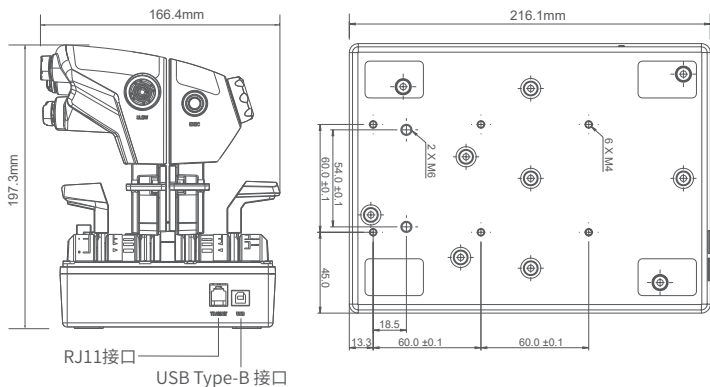

02 使用教程

连接PC

1. 直接连接PC

使用附赠的USB线，将Type-B端分别插入MTQ油门尾部对应接口上，另一头Type-A端接入PC，若成功连接则设备灯光逐渐亮起，MOZA Cockpit中将显示设备已连接。

*若设备灯光无亮起，在MOZA Cockpit中检查灯光亮度是否被关闭。

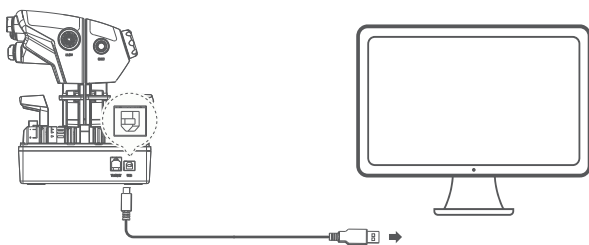

2. 通过基座连接PC

使用附赠的RJ11线，将一段连接MTQ油门尾部对应的接口上，另一头连接至MOZA飞行模拟基座，将基座通电，若成功连接则设备灯光亮起，MOZA Cockpit中将显示设备已连接。

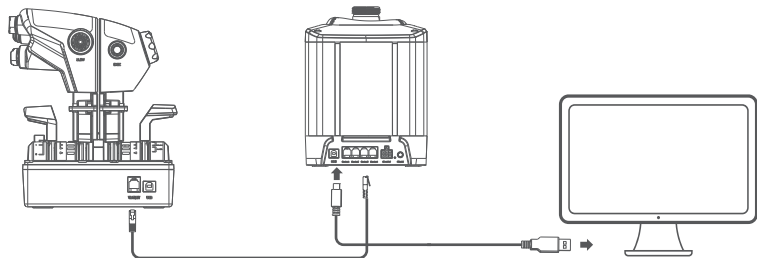

调节滑动摩擦

如需增加杆头滑动摩擦力,请使用附赠扳手顺时针旋转图中螺丝。如需减少,则逆时针旋转。

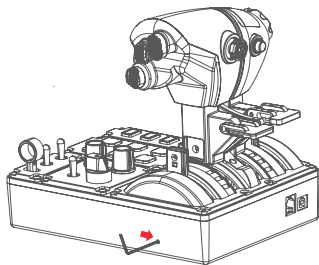

更换油门组件

- 1.需更换油门杆头套件,请首先使用包装内附赠的专用扳手,松开图示位置的固定螺丝。
- 2.螺丝松开后,轻轻拔出原有杆头。
- 3.将购买的新杆头组件对准连接杆插入,直至无法进一步压紧且保持固定无晃动
使用附赠的扳手和螺丝刀对准图示位置拧紧螺丝,确保杆头固定无晃动

*TQA和TQB需要单独购买

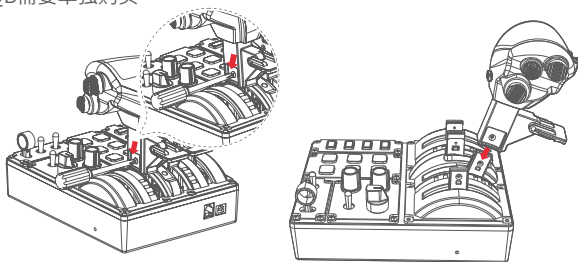

加装MTQ支撑板

将MTQ支撑板孔位对准图中MTQ设备底部螺丝孔位,使用附赠扳手顺时针旋入两颗螺丝并锁紧,即可完成安装。

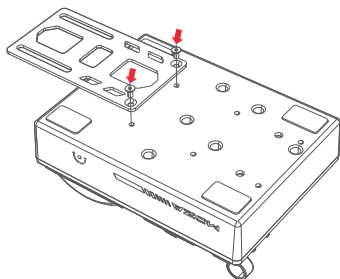

03 软件介绍

MTQ油门面板设置

当用户更换油门杆头时，面板右侧的示意图也会相应地发生变化。

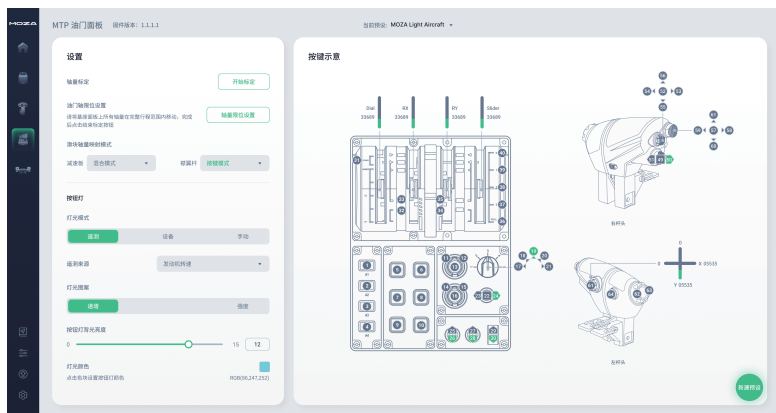

轴量标定

油门面板的轴量出厂时已经完成了轴量标定，因此您可以直接使用油门的功能。

如果您在使用过程中，发现TQF上摇杆的轴量输出与实际推动的行程无法匹配时，说明此时您可能需要使用轴量标定功能来进行校准。要开始标定轴量，首先点击界面上的“开始标定”按钮。接下来，按照弹窗中的提示，在倒计时结束前，摇杆在完整的行程内来回移动。标定结束后，您便可以正常使用摇杆功能。



轴量限位设置

启用“轴量限位设置”后，用户可将油门轴的物理行程精准映射至游戏逻辑轴量，同时划定战斗机常用的关断、慢车和加力区域。

通过设置弹窗，可标定左右油门杆的限位区段，系统将自动新增6个虚拟按键，对应左/右杆的关断、慢车和加力位置。

标定完成后，可在“轴量输出”区域查看左/右油门的标定状态。

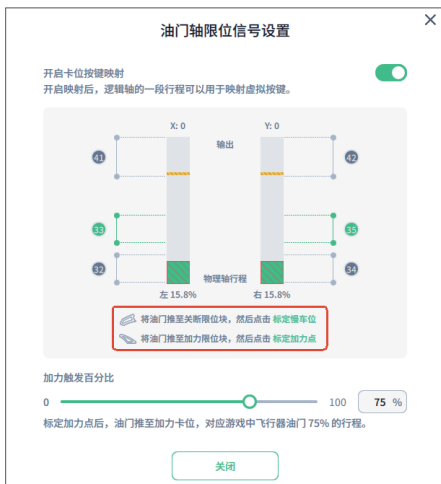

滑块轴映射模式说明

用户可以调节减速板和襟翼杆的轴量输入模式。用户可以选择3种映射模式：

- 按键模式
- 轴量模式
- 混合模式



灯光控制模式

灯光控制模式决定了上位机软件如何控制按钮灯。用户可以选择2种灯光控制模式：

- 设备模式
- 手动模式

在设备模式下，用户可以选择一个设备轴量作为灯光变化的依据。例如，您可以选择使用减速板轴的输入量作为灯光控制参数；减速板轴量增加时，灯光会按照选定的图案模式亮起。

在手动模式下，用户可以直接通过灯光亮度滑块和灯效下拉选择菜单来调整灯效。

按钮灯与灯效说明

本设备支持多种背光与灯效，用户可通过驱动软件调节按钮灯组的显示模式与颜色，打造个性化光效体验。

支持功能包括：

- 多种灯效模式（常亮、闪烁、呼吸等）
- 按键灯效联动反馈
- 1600 万色 RGB 背光调色
- 指示图案与亮度调节

用户可点击Cockpit界面进行颜色设置，选择喜好的灯光风格与亮度效果。

04 注意事项

- 严禁将设备暴露在雨水以及潮湿的环境中，以避免发生火灾/电击
- 严禁在太阳直射的条件下使用设备
- 严禁接入MOZA赛车模拟器生态产品
- 建议室内温度:5°C ~ 30°C
- 为了您的健康，请合理控制游戏时间
- 设备不适用于6岁以下儿童，小配件可能造成窒息的危险!
- 13岁以下孩童需在家长陪同下使用
- 严禁自行拆解设备，否则将失去质保资格
- 设备必须使用配套出厂的电源进行连接，以保障用电安全及用户权益得到保障
- 为保障相关安全，零部件维修或者更换只能由官方授权维修中心进行
- 即使相关电压等数据匹配，亦禁止使用非标准电源
- 只能使用标准壁式电源插座提供的交流电源以避免对产品造成损坏
- 禁止将设备暴露在热源中
- 长期不使用的情况下，请拔出设备电源线断电
- 如发现有任何异常，请立即停止使用并寻求 MOZA 官方或相关授权中心的帮助
- 请关注 MOZA 官网及公众平台以了解最新的相关产品信息

产品保修卡

产品型号		购买日期	
用户姓名		用户电话	
产品条码		通讯地址	

经销商信息(签章)

产品保修条例

保修期

自购机日起,基座主体,方向盘,踏板和仪表显示屏保修12个月。设备外壳、说明书、线材、螺丝、扳手、包装等不在"一年免费保修服务"范围内,但您可以选择有偿服务。

购买者在以下条件下不享受免费保修服务,但您可以选择有偿服务。

1. 超过三包有效期的;
2. 无三包凭证及有效发票的,但能够证明该产品在三包有效期内的除外;
3. 包修凭证上的型号与修理产品型号不符或者涂改的;
4. 非本公司特约维修人员拆动造成损坏的;
5. 因不可抗力力造成损坏的;
6. 未按产品使用说明书要求使用、维护、保养而造成损坏的。

保修期限鉴于产品部位、不同国家法律法规等差异,将有所不同。相关国家与区域的保修期限,请咨询MOZA官方或购买时联系的MOZA授权经销商。





Manufacturer: Shenzhen Gudsen Technology Co., Ltd

Address: Room 1903-1904, Building 3, Nanshan
ZhiyuanChongwen Park, No. 3370 Liuxian Avenue,
Nanshan District, Shenzhen China

Web: www.mozaracing.com

E-mail: info@mozaracing.com

Made in China

EU Representative: Gudsen Technology EU GmbH

Address: Birkenstrasse 23, 40233 Düsseldorf
Contact: JUNWEN DING
Email: support@gudsen.com

UK Representative: Gudsen Technology UK Limited

Address: Tc-Abo, Luminous House, 300 South Row
Milton Keynes, MK9 2FR, United Kingdom
Contact: JUNWEN DING
Email: support@gudsen.com